

Portable ultrasonic flow measurement of liquids in hazardous areas

Portable instrument for non-invasive, quick ultrasonic flow measurement with clamp-on technology for all types of piping

Features

- Precise bidirectional and highly dynamic flow measurement with the non-invasive clamp-on technology
- High precision at fast and slow flow rates, high temperature and zero point stability
- Portable, easy-to-use flow transmitter with 2 flow channels, multiple inputs, an integrated data logger with a serial interface
- Extremely resistant carbon fiber housing
- Covered by FM Class I Div. 2 certification
- Compact and very lightweight, allowing the measuring system to be easily carried as personal luggage, e.g. for offshore visits
- Water tight; resistant against oil, many liquids and dirt
- Li-Ion battery provides up to 25 hours of measurement operation
- Automatic loading of calibration data and transducer detection for a fast and easy set-up (less than 5 min), providing precise and long-term stable results
- User-friendly design
- Transducers available for a wide range of inner pipe diameters and fluid temperatures (-200...+600 °C)
- Rugged transducers (FM Class I Div. 2, resistant to rough environments and humidity)
- Robust, water-tight (IP67) transport case with comprehensive accessories
- HybridTrek automatically switches between transit time and NoiseTrek mode of measurement when high particulate flows are encountered
- QuickFix for fast mounting of the flow transmitter in difficult conditions
- Measurement is unaffected by fluid density, viscosity and solid content (max. 10 % of volume)

Applications

Designed for the following industries:

- Upstream (on- and offshore)
- Midstream and downstream (pipelines and refineries)
- Chemical industry
- Energy sector (e.g. HVAC, geothermal, power plants)



FLUXUS F608



Measurement with transducers mounted with the portable Variofix VP



Measurement with the flow transmitter fixed to the pipe with the QuickFix pipe mounting fixture

Function 3
 Measurement principle 3
 Calculation of volumetric flow rate 3
 Number of sound paths 4
 Typical measurement setup 4

Transmitter 5
 Technical data 5
 Dimensions 6
 Standard scope of supply 6
 Adapters 7

Transducers 8
 Transducer selection 8
 Transducer order code 9
 Technical data 10

Transducer mounting fixture 12

Coupling materials for transducers 14

Connection systems 15

Clamp-on temperature probe (optional) 16
 Technical data 16
 Fixation 17

Wall thickness measurement (optional) 18
 Technical data 18

Function

Measurement principle

The transducers are mounted on the pipe which is completely filled with the fluid. The ultrasonic signals are emitted alternately by a transducer and received by the other. The physical quantities are determined from the transit times of the ultrasonic signals.

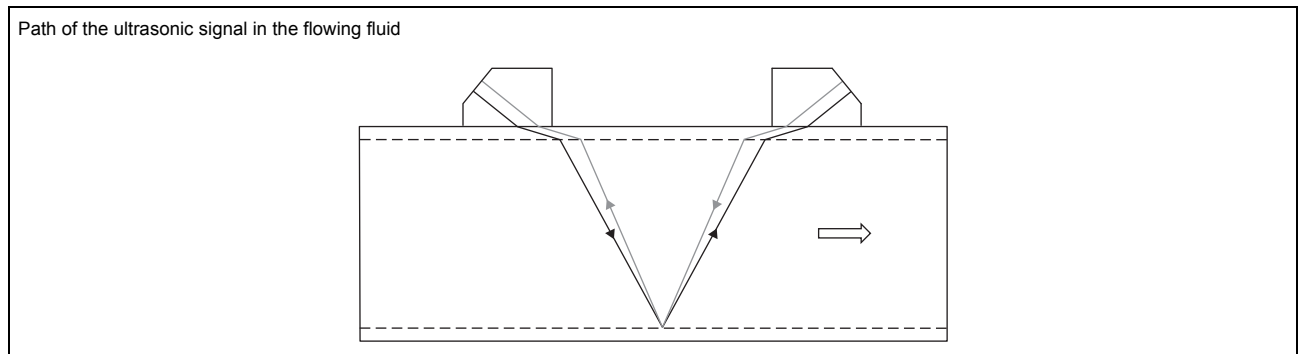

Transit time difference principle

As the fluid where the ultrasound propagates is flowing, the transit time of the ultrasonic signal in flow direction is shorter than the one against the flow direction.

The transit time difference Δt is measured and allows the flowmeter to determine the average flow velocity along the propagation path of the ultrasonic signals. A flow profile correction is then performed in order to obtain the area averaged flow velocity, which is proportional to the volumetric flow rate.

The integrated microprocessors control the entire measuring cycle. The received ultrasonic signals are checked for measurement usability and evaluated for their reliability. Noise signals are eliminated.

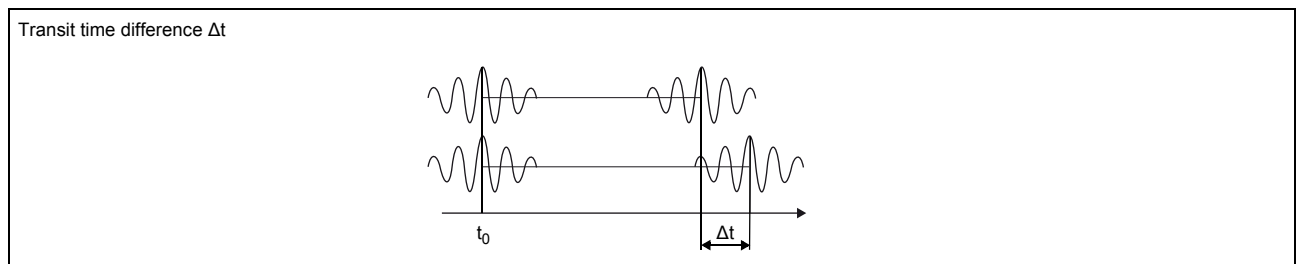

HybridTrek

If the gaseous or solid content in the fluid increases occasionally during measurement, a measurement with the transit time difference principle is no longer possible. NoiseTrek mode will then be selected by the flowmeter. This measurement method allows the flowmeter to achieve a stable measurement even with high gaseous or solid content.

The transmitter can switch automatically between transit time and NoiseTrek mode without any changes to the measurement setup.

Calculation of volumetric flow rate

$$\dot{V} = k_{Re} \cdot A \cdot k_a \cdot \frac{\Delta t}{2 \cdot t_y}$$

where

- \dot{V} - volumetric flow rate
- k_{Re} - fluid mechanics calibration factor
- A - cross-sectional pipe area
- k_a - acoustical calibration factor
- Δt - transit time difference
- t_y - average of transit times in the fluid

Number of sound paths

The number of sound paths is the number of transits of the ultrasonic signal through the fluid in the pipe. Depending on the number of sound paths, the following methods of installation exist:

- **reflection arrangement**

The number of sound paths is even. The transducers are mounted on the same side of the pipe. Correct positioning of the transducers is easier.

- **diagonal arrangement**

The number of sound paths is odd. The transducers are mounted on opposite sides of the pipe. In the case of a high signal attenuation by the fluid, pipe and coatings, diagonal arrangement with 1 sound path will be used.

The preferred method of installation depends on the application. While increasing the number of sound paths increases the accuracy of the measurement, signal attenuation increases as well. The optimum number of sound paths for the parameters of the application will be determined automatically by the transmitter.

As the transducers can be mounted with the transducer mounting fixture in reflection arrangement or diagonal arrangement, the number of sound paths can be adjusted optimally for the application.

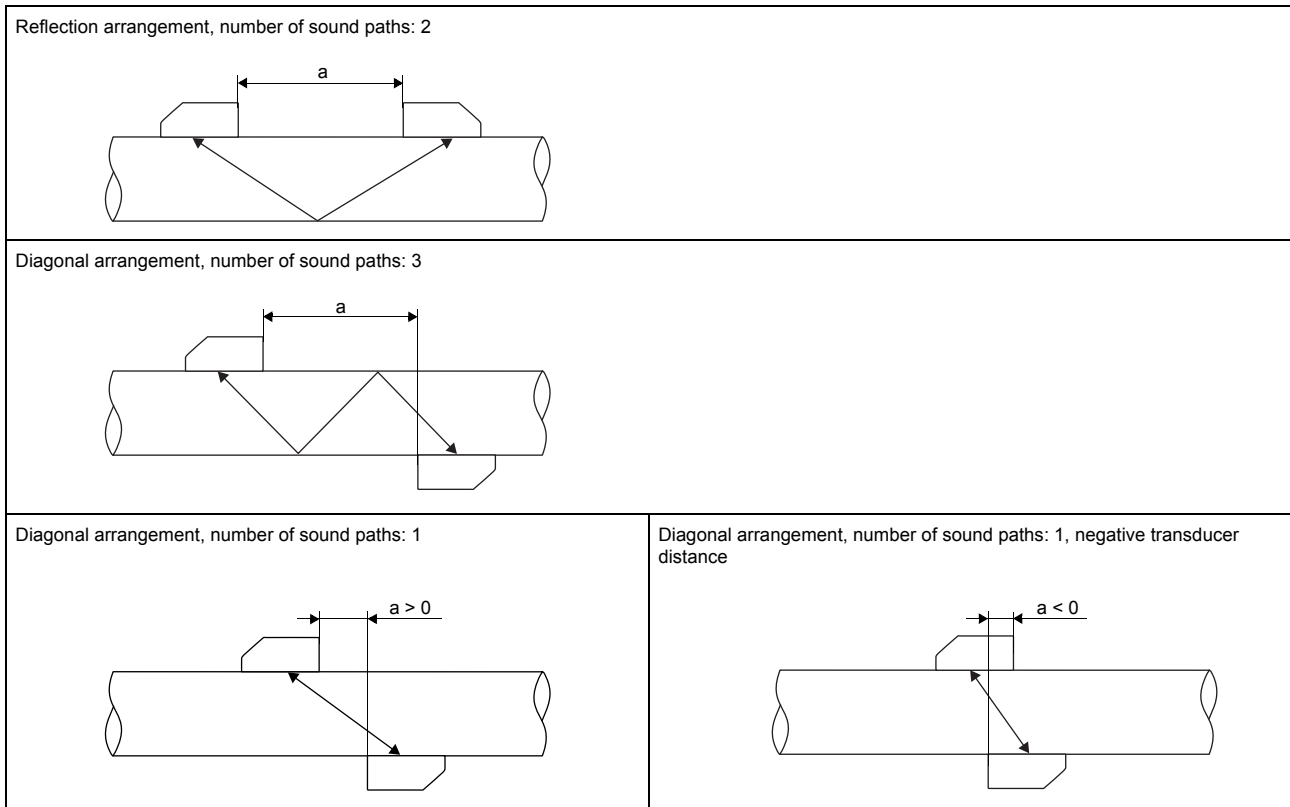

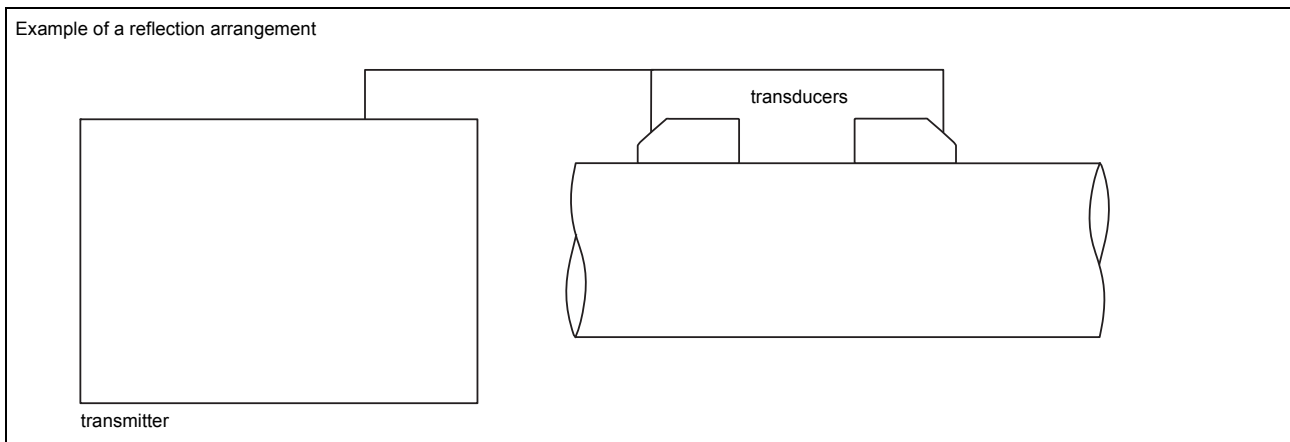

a - transducer distance

Typical measurement setup



Transmitter

Technical data

		FLUXUS F608**-F2
		
design		portable, FM Class I Div. 2
measurement		
measurement principle		transit time difference correlation principle, automatic NoiseTrek selection for measurements with high gaseous or solid content
flow velocity	m/s	0.01...25
repeatability		0.15 % of reading ±0.005 m/s
fluid		all acoustically conductive liquids with < 10 % gaseous or solid content in volume (transit time difference principle)
temperature compensation		corresponding to the recommendations in ANSI/ASME MFC-5.1-2011
measurement uncertainty (volumetric flow rate)		
measurement uncertainty of measuring system ¹		±0.3 % of reading ±0.005 m/s
measurement uncertainty at the measuring point ²		±1 % of reading ±0.005 m/s
transmitter		
power supply		<ul style="list-style-type: none"> • 100...230 V/50...60 Hz (power supply unit, outside of explosive atmosphere) • 10.5...15 V DC (socket at transmitter) • integrated battery
integrated battery		Li-Ion, 7.2 V/6.2 Ah
• operating time	h	<ul style="list-style-type: none"> • > 14 h (without inputs and backlight) • > 25 h (1 measuring channel, ambient temperature > 10 °C, without inputs and backlight)
power consumption	W	< 6 (with inputs and backlight), charging: 18
number of measuring channels		2
damping	s	0...100 (adjustable)
measuring cycle	Hz	100...1000 (1 channel)
response time	s	1 (1 channel), option: 0.07
housing material		PA, TPS, PC, Polyester, stainless steel
degree of protection		IP65
dimensions	mm	see dimensional drawing
weight	kg	2.2
fixation		QuickFix pipe mounting fixture
ambient temperature	°C	-10...+60
display		2 x 16 characters, dot matrix, backlight
menu language		English, German, French, Dutch, Spanish
explosion protection		
• FM		
marking		 NI/Cl. I /Div. 2 / GP. A,B,C,D / T5 Ta = 60 °C
measuring functions		
physical quantities		volumetric flow rate, mass flow rate, flow velocity, heat flow (if temperature inputs are installed)
totalizer		volume, mass, optional: heat quantity
calculation functions		average, difference, sum
diagnostic functions		sound speed, signal amplitude, SNR, SCNR, standard deviation of amplitudes and transit times
communication interfaces		
service interfaces		<ul style="list-style-type: none"> • RS232 • USB (with adapter)
accessories		
serial data kit		
• cable		RS232
• adapter		RS232 - USB
software		<ul style="list-style-type: none"> • FluxDiagReader: download of measured values and parameters, graphical presentation • FluxDiag (optional): download of measurement data, graphical presentation, report generation • FluxSubstanceLoader: upload of fluid data sets
adapter		• input adapter (if number of inputs > 2)
transport case		dimensions: 500 x 400 x 190 mm
data logger		
loggable values		all physical quantities, totalized values and diagnostic values
capacity		> 100 000 measured values

¹ with aperture calibration of the transducers

² for transit time difference principle and reference conditions

FLUXUS F608**-F2	
inputs	
	The inputs are galvanically isolated from the transmitter.
number	max. 4
• temperature input	
type	Pt100/Pt1000
connection	4-wire
range	°C -150...+560
resolution	K 0.01
accuracy	±0.01 % of reading ±0.03 K

¹ with aperture calibration of the transducers

² for transit time difference principle and reference conditions

Dimensions

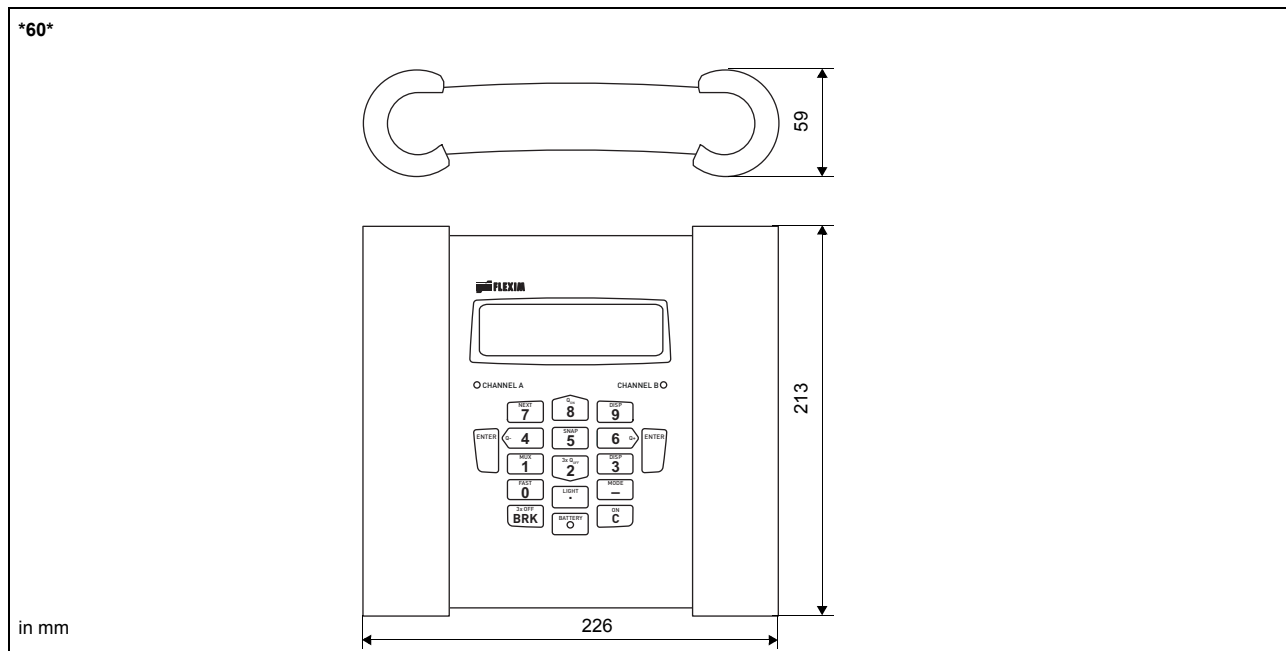

Standard scope of supply

	F608 Standard	F608 Energy
application	flow measurement of liquids	
	2 independent measuring channels	
		temperature-compensated calculation of mass flow rate
		integrated heat flow computer for monitoring of energy flows
		simultaneous monitoring of flow and energy flow
inputs		
temperature input	-	2
accessories		
transport case	x	x
power supply unit, mains cable	x	x
battery	x	x
input adapter	-	-
QuickFix pipe mounting fixture for transmitter	x	x
serial data kit	x	x
measuring tape	x	x
user manual, safety instructions, Quick start guide	x	x
connector board at the upper side of the transmitter		

Adapters

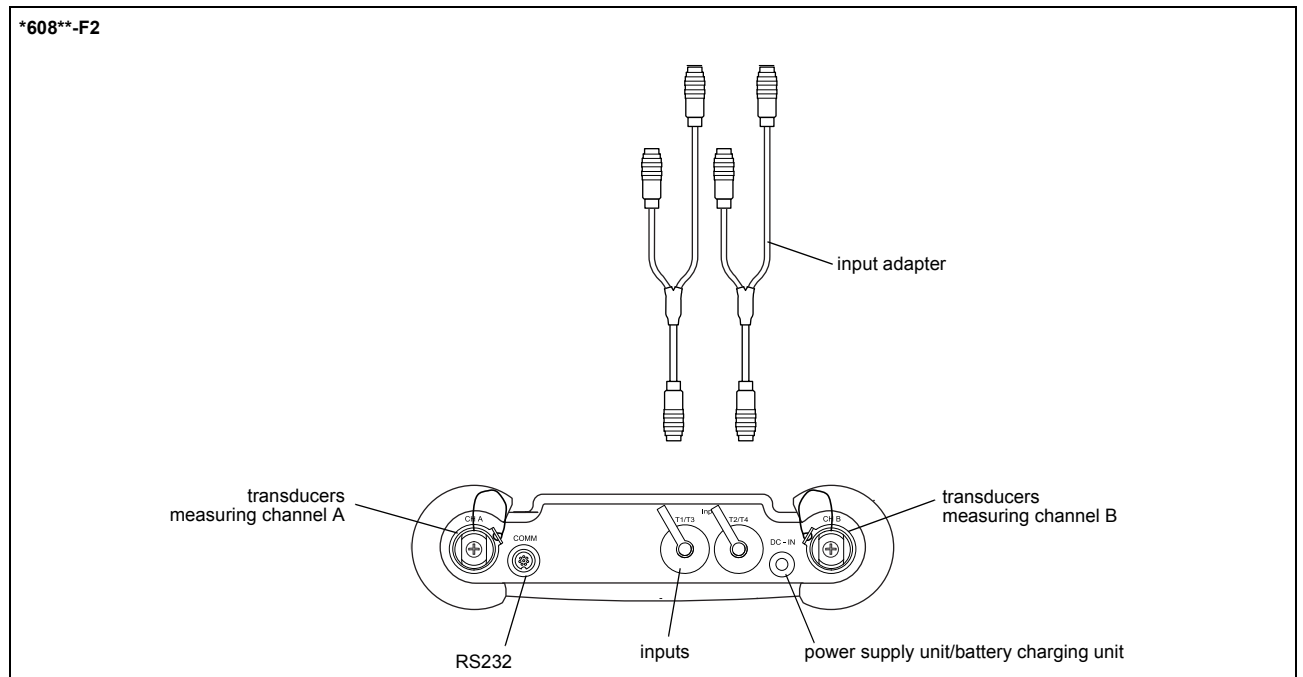

Transducers

Transducer selection

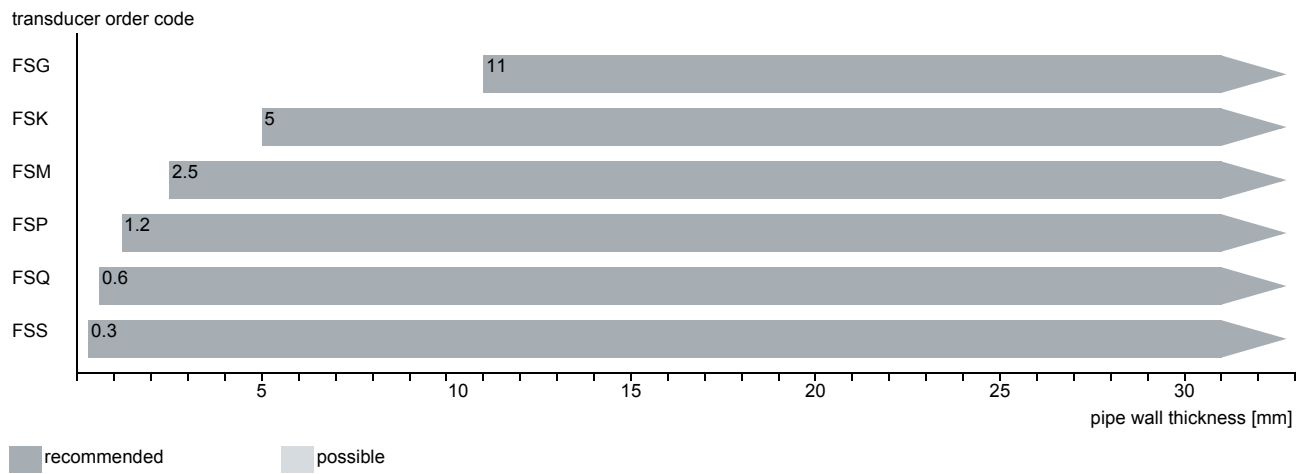
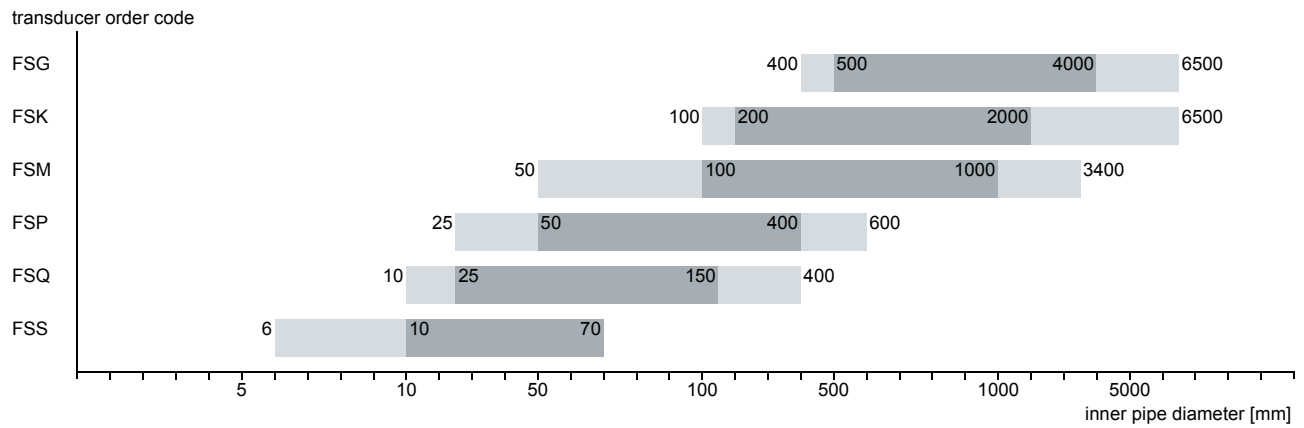

Transducer order code



1, 2	3	4	5, 6	7, 8	9...11	no. of character				
transducer	transducer frequency	-	ambient temperature	explosion protection	connection system	-	extension cable	/	option	description
FS										set of ultrasonic flow transducers for liquids measurement, shear wave
	G									0.2 MHz
	K									0.5 MHz
	M									1 MHz
	P									2 MHz
	Q									4 MHz
	S									8 MHz
		N								normal temperature range
		E								extended temperature range
			F2							FM Class I Div. 2
				NL						with Lemo connector
						XXX				0 m: without extension cable > 0 m: with extension cable
								LC		long transducer cable

Technical data

Shear wave transducers (FM Class I Div. 2, NL)

order code	FSG-NF2NL/**	FSK-NF2NL/**	FSM-NF2NL/**	FSP-NF2NL/**	FSQ-NF2NL/**	FSS-NF2NL/**	
technical type	C(DL)G1N51	C(DL)K1N51	C(DL)M1N51	C(DL)P1N51	C(DL)Q1N51	CDS1N51	
transducer frequency /MHz	0.2	0.5	1	2	4	8	
inner pipe diameter d							
min. extended	mm 400	100	50	25	10	6	
min. recommended	mm 500	200	100	50	25	10	
max. recommended	mm 4000	2000	1000	400	150	70	
max. extended	mm 6500	6500	3400	600	400	70	
pipe wall thickness							
min.	mm 11	5	2.5	1.2	0.6	0.3	
material							
housing	PEEK with stainless steel cap 304 (1.4301)		stainless steel 304 (1.4301)		stainless steel 304 (1.4301)		
contact surface	PEEK		PEEK		PEI		
degree of protection	IP67		IP67		IP65		
transducer cable							
type	1699						
length	m 5	4		3	2		
length (***.*****/LC)	m 9	-					
dimensions							
length l	mm 129.5	126.5	60		42.5	25	
width b	mm 51	51	30		18	13	
height h	mm 67	67.5	33.5		21.5	17	
dimensional drawing							
weight (without cable)	kg 0.47	0.36	0.035		0.011	0.004	
pipe surface temperature							
min.	°C -40					-30	
max.	°C +130					+130	
ambient temperature							
min.	°C -40					-30	
max.	°C +130					+130	
temperature compensation	x					-	
explosion protection							
• FM							
pipe surface temperature (Ex)							
• min.	°C -40						
• max.	°C +125						
degree of protection	IP66						
marking	 NI/CI. I,II,III/Div. 2 / GP A,B,C,D,E,F,G/ Temp. Codes dwg 3860						

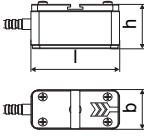
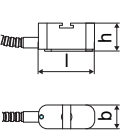
Shear wave transducers (FM Class I Div. 2, NL, extended temperature range)

order code		FSM-EF2NL/**	FSP-EF2NL/**	FSQ-EF2NL/**
technical type		C(DL)M1E51	C(DL)P1E51	C(DL)Q1E51
transducer frequency	MHz	1	2	4
inner pipe diameter d				
min. extended	mm	50	25	10
min. recommended	mm	100	50	25
max. recommended	mm	1000	400	150
max. extended	mm	3400	600	400
pipe wall thickness				
min.	mm	2.5	1.2	0.6
material				
housing		stainless steel 304 (1.4301)		
contact surface		Sintimid		
degree of protection		IP65		
transducer cable				
type		1699		
length	m	4		3
length (**-****/LC)	m	9		
dimensions				
length l	mm	60		42.5
width b	mm	30		18
height h	mm	33.5		21.5
dimensional drawing				
weight (without cable)	kg	0.042		0.011
pipe surface temperature				
min.	°C	-30		
max.	°C	+200		
ambient temperature				
min.	°C	-30		
max.	°C	+200		
temperature compensation		x		
explosion protection				
• FM				
pipe surface temperature (Ex)				
• min.	°C	-40		
• max.	°C	+190		
degree of protection		IP66		
marking		 NI/Cl. I,II,III/Div. 2 / GP A,B,C,D,E,F,G/ Temp. Codes dwg 3860		

Transducer mounting fixture

Order code

1, 2	3	4	5	6	7...9	no. of character
transducer mounting fixture	transducer	measurement arrangement	size	fixation	outer pipe diameter	description
FS						fastening shoes (transducers with transducer frequency S)
VP						portable Variofix
TB						tension belts
WL						transducer box for WaveInjector
	A					all transducers
	K					transducers with transducer frequency G, K
	M					transducers with transducer frequency M, P
	Q					transducers with transducer frequency Q
	S					transducers with transducer frequency S
		D				reflection arrangement or diagonal arrangement
		R				reflection arrangement
			S			small
			M			medium
				C		chains
				N		without fixation
					010	10...100 mm
					025	10...250 mm
					055	10...550 mm
					150	50...1500 mm
					210	50...2100 mm

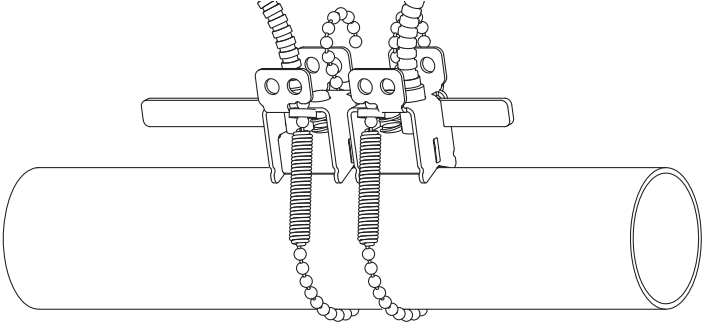
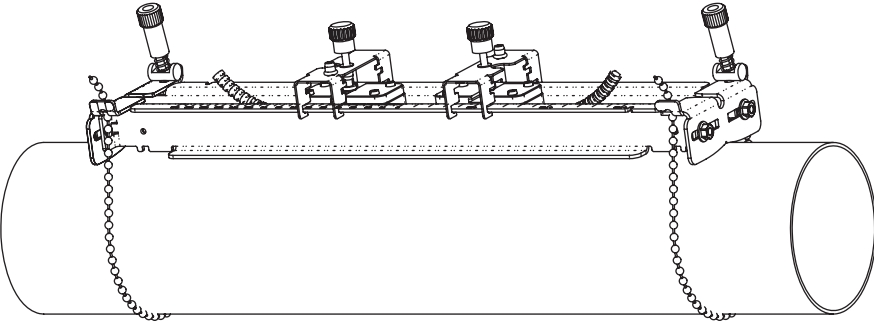
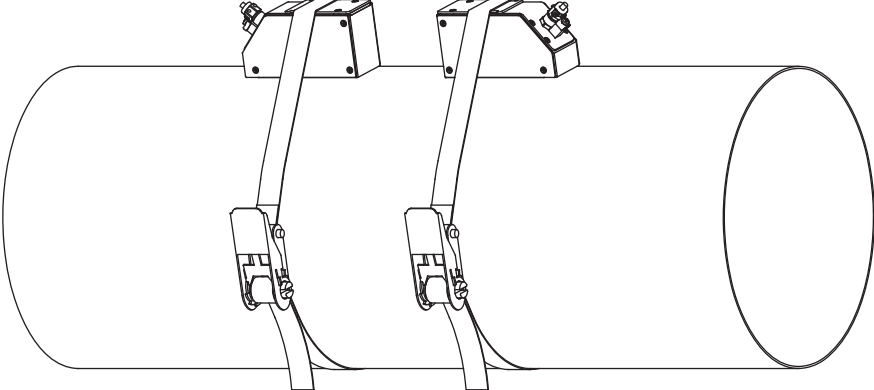
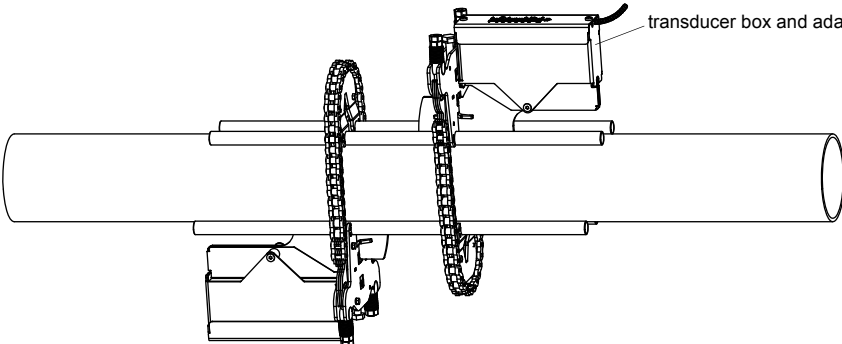
<p>fastening shoes FS and chains</p> 	<p>transducer frequency: S</p> <p>material: stainless steel 304 (1.4301), 301 (1.4310), 303 (1.4305)</p> <p>dimensions: 210 x 32 x 44 mm</p> <p>chain length: 0.5 m</p> <p>outer pipe diameter: max. 150 mm</p>
<p>portable Variofix VP and chains</p> 	<p>material: stainless steel 304 (1.4301), 301 (1.4310), 303 (1.4305)</p> <p>dimensions: 414 x 94 x 76 mm</p> <p>chain length: 2 m</p>
<p>tension belts TB</p> 	<p>material: steel, powder coated and textile tension belt</p> <p>length: 5/7 m</p> <p>ambient temperature: max. 60 °C</p> <p>outer pipe diameter: max. 1500/2100 mm</p>
<p>transducer box WL for WaveInjector</p>  <p style="text-align: right;">transducer box and adap-</p>	<p>see Technical specification TSWaveInjectorVx-x</p>

Coupling materials for transducers

normal temperature range (4th character of transducer order code = N)		extended temperature range (4th character of transducer order code = E)		WaveInjector WI-400	
< 100 °C	< 170 °C	< 150 °C	< 200 °C	< 280 °C	280...400 °C
coupling compound type N	coupling compound type E	coupling compound type E	coupling compound type E or H	coupling foil type A and coupling foil type VT	coupling foil type B and coupling foil type VT

Technical data

type	ambient temperature °C
coupling compound type N	-30...+130
coupling compound type E	-30...+200
coupling compound type H	-30...+250
coupling foil type A	max. 280
coupling foil type B	280...400
coupling foil type VT	-10...+200

Connection systems

connection system NL	
direct connection/connection with extension cable	transducers technical type *****51

Cable

transducer cable		
type		1699
weight	kg/m	0.094
ambient temperature	°C	-55...+200
cable jacket		
material		PTFE
outer diameter	mm	2.9
thickness	mm	0.3
colour		brown
shield		x
sheath		
material		stainless steel 304 (1.4301)
outer diameter	mm	8

extension cable		
type		1750
standard length	m	5 10
weight	kg/m	0.12
ambient temperature	°C	< 80
cable jacket		
material		PE
outer diameter	mm	6
thickness	mm	0.5
colour		black
shield		x
sheath		
material		stainless steel 304 (1.4301)
outer diameter	mm	9

Cable length

transducer frequency	F, G, H, K			M, P			Q			S			
connection system NL													
transducers technical type	x	y	l	x	y	l	x	y	l	x	y	l	
*(DR)***51	m	2	3	≤ 10	2	2	≤ 10	2	1	≤ 10	1	1	≤ 10
option LC: *(LT)***51	m	2	7	≤ 10	7	2	≤ 10	8	1	≤ 10	-	-	-

x, y - transducer cable length

l - max. length of extension cable

Clamp-on temperature probe (optional)

Technical data

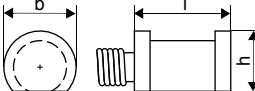
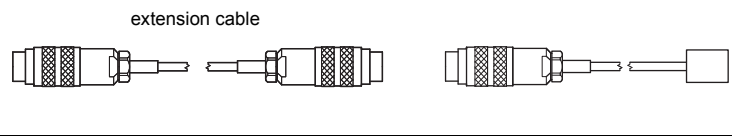
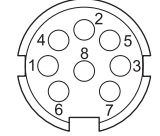
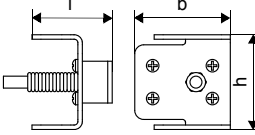
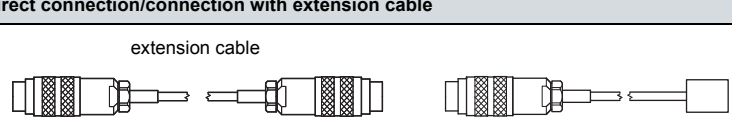
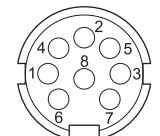
PT12N			
design	clamp-on with connector		
type	Pt100		
connection	4-wire		
measuring range	°C -30...+250		
accuracy T	$\pm(0.15\text{ °C} + 2 \cdot 10^{-3} \cdot T\text{ [°C]})$ class A		
accuracy ΔT (2x Pt matched according to EN 1434-1)	$\leq 0.1\text{ K}$ ($3\text{ K} < \Delta T < 6\text{ K}$), more corresponding to EN 1434-1		
response time	s	50	
housing	aluminum		
degree of protection	IP66		
dimensions			
length l	mm	20	
width b	mm	15	
height h	mm	13	
dimensional drawing			
weight	kg	0.25 (without connector)	
accessories			
thermal conductivity paste 200 °C	x		
thermal conductivity foil 250 °C	x		
Connection system			
direct connection/connection with extension cable			
			
Connection			
	temperature probe	extension cable	connector
			pin
	red	grey	2
	red/blue	red	6
	white/blue	blue	1
	white	white	7
			
Cable			
	temperature probe	extension cable	
type	4 x 0.25 mm ² black	LIYCY 8 x 0.14 mm ² grey	
standard length	m 3	5/10/25	
max. length	m -	100	
cable jacket	PTFE	PVC	
PT12F			
design	clamp-on short response time, with connector		
type	Pt100		
connection	4-wire		
measuring range	°C -50...+250		
accuracy T	$\pm(0.15\text{ °C} + 2 \cdot 10^{-3} \cdot T\text{ [°C]})$ class A		
accuracy ΔT (2x Pt matched according to EN 1434-1)	$\leq 0.1\text{ K}$ ($3\text{ K} < \Delta T < 6\text{ K}$), more corresponding to EN 1434-1		
response time	s	8	
housing	PEEK, stainless steel 304 (1.4301), copper		
degree of protection	IP66		
dimensions			
length l	mm	14	
width b	mm	30	
height h	mm	27	
dimensional drawing			
weight	kg	0.32 (without connector)	
accessories			
thermal conductivity paste 200 °C	x		
thermal conductivity foil 250 °C	x		
plastic protection plate, insulation foam	x		
Connection system			
direct connection/connection with extension cable			
			
Connection			
	temperature probe	extension cable	connector
			pin
	red	grey	2
	red/blue	red	6
	white/blue	blue	1
	white	white	7
			
Cable			
	temperature probe	extension cable	
type	4 x 0.25 mm ² black	LIYCY 8 x 0.14 mm ² grey	
standard length	m 3	5/10/25	
max. length	m -	100	
cable jacket	PTFE	PVC	

Fixation

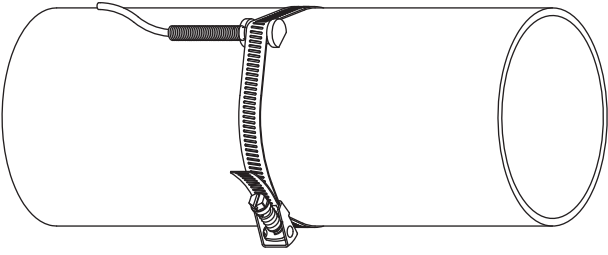
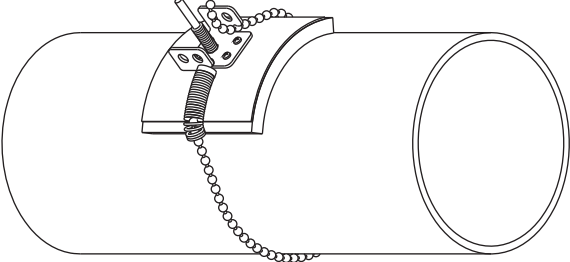
<p>tension strap PT12N</p>  <p>The diagram shows a cylindrical component with a tension strap PT12N attached to its side. The strap is made of a woven material and is secured with a metal fastener that has a spring mechanism, allowing it to be adjusted and locked.</p>	<p>material: stainless steel 301 (1.4310), 410 (1.4006)</p>
<p>ball chain PT12F</p>  <p>The diagram shows a cylindrical component with a ball chain PT12F attached to its side. The chain is made of stainless steel and is connected to a metal bracket that is bolted to the component. The chain hangs down from the bracket.</p>	<p>material: stainless steel 316L (1.4404) length: 1 m</p>

Wall thickness measurement (optional)

The pipe wall thickness is an important pipe parameter which has to be determined exactly for a good measurement. However, the pipe wall thickness often is unknown.

The wall thickness probe can be connected to the transmitter instead of the flow transducers and the wall thickness measurement mode is activated automatically.

Acoustic coupling compound is applied to the wall thickness probe which then is placed firmly on the pipe. The wall thickness is displayed and can be stored directly in the transmitter.

Technical data

DWR1NZ7		
measuring range ¹	mm	1...250
resolution	mm	0.01
accuracy		1 % ±0.1 mm
fluid temperature	°C	-20...+200, short-time peak max. 500
explosion protection		-
cable		
type		2616
length	m	1.5

¹ The measuring range depends on the attenuation of the ultrasonic signal in the pipe. For strongly attenuating plastics (e.g. PFA, PTFE, PP) the measuring range is smaller.

Cable

2616		
ambient temperature	°C	<200
cable jacket		
material		FEP
outer diameter	mm	5.1
colour		black
shield		x

